



EQUIPMENT CATALOG

2026

 **BODYKORE**

 **BODYKORE**

#WEAREBODYKORE

About Us

BodyKore is committed to leading the global fitness industry with state-of-the-art commercial equipment, innovative design, and exceptional service. Our mission is to deliver high-quality, performance-driven products that empower individuals to achieve their fitness goals while ensuring an outstanding customer experience.



Advance



Innovation

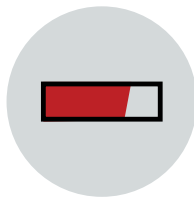

Progress



What We Do

BodyKore is a full-service fitness equipment company specializing in the design, manufacturing, and distribution of high-performance strength and conditioning machines. From concept to production, we engineer biomechanically optimized equipment that meets the demands of both home and commercial fitness spaces.

With a nationwide dealer network in the USA and an expanding presence in Mexico, Canada, and Europe, we make premium fitness solutions accessible worldwide. More than just equipment, we provide expert guidance and ongoing support to gyms, training facilities, and fitness enthusiasts.

By merging cutting-edge design, durability, and functionality, we help create spaces that inspire performance—from health clubs and boutique studios to home gyms.

Visit us by scanning this QR code



TABLE OF CONTENTS

Performance Technologies	pg. 4
Expert 3D Design Service	pg. 5
Custom Upholstery and More	pg. 7
Commercial Gyms	
Collins Aerospace	pg. 9
Edge Fitness	pg. 10
Booty by Barbell	pg. 11
Retro Home Gym	pg. 12
Isolation Series	pg. 13
Signature Series	pg. 19
Elite Series	pg. 25
Foundation Series	pg. 30
Pro Performance Storage System	pg. 34
Alliance Series	pg. 37
Universal Series	pg. 41
Stacked Series	pg. 45
Smart Sled Pro	pg. 50
Index	pg. 53

PERFORMANCE TECHNOLOGIES



Easy Assembly

Each package includes up-to-date assembly and installation instructions, guaranteeing that equipment is assembled efficiently and to the highest standard.



Streamlined Adjustable Pulley System

Engineered for the smoothest weight lifting experience, this system offers seamless adjustability and fluid movement.



Precision Cut Selectorized Weights

Engineered for optimal performance, each weight is precision-cut, ensuring a refined appearance and purposeful design for maximum efficiency in use.



Rolled Steel Oval Tubing

Corrosion resistant and stainless material designed to maximize life-span and durability.



Water Resistant Upholstery

Featuring water-resistant upholstery that prevents water ingress, significantly extending the lifespan and durability of our equipment.



Proprietary Attachment System

Our unique system supports various attachments, enabling personal modifications to tailor each piece of equipment to your specific needs.



Linear Bearing Guide Rod System

Enhances load capacity and smooth operation with minimal stiffness and friction, enhancing our equipment's durability and performance.



Industrial Galvanized Steel Cables

Our cables are strong, durable, corrosion-resistant, heat resistant, and internally lubricated ensuring utmost safety and reliability in all our machines.



CB Smith Machine

Expertly designed for enhanced stability and control, this counter balanced unit enables diverse workouts targeting various muscle groups.



Ultra Stainless Steel Fastener

Sturdy and durable, designed for effortless setup, adjustment, and mobility, ensuring seamless use without any complications.

BRING YOUR **DREAM GYM** TO LIFE WITH OUR EXPERT 3D DESIGN SERVICE

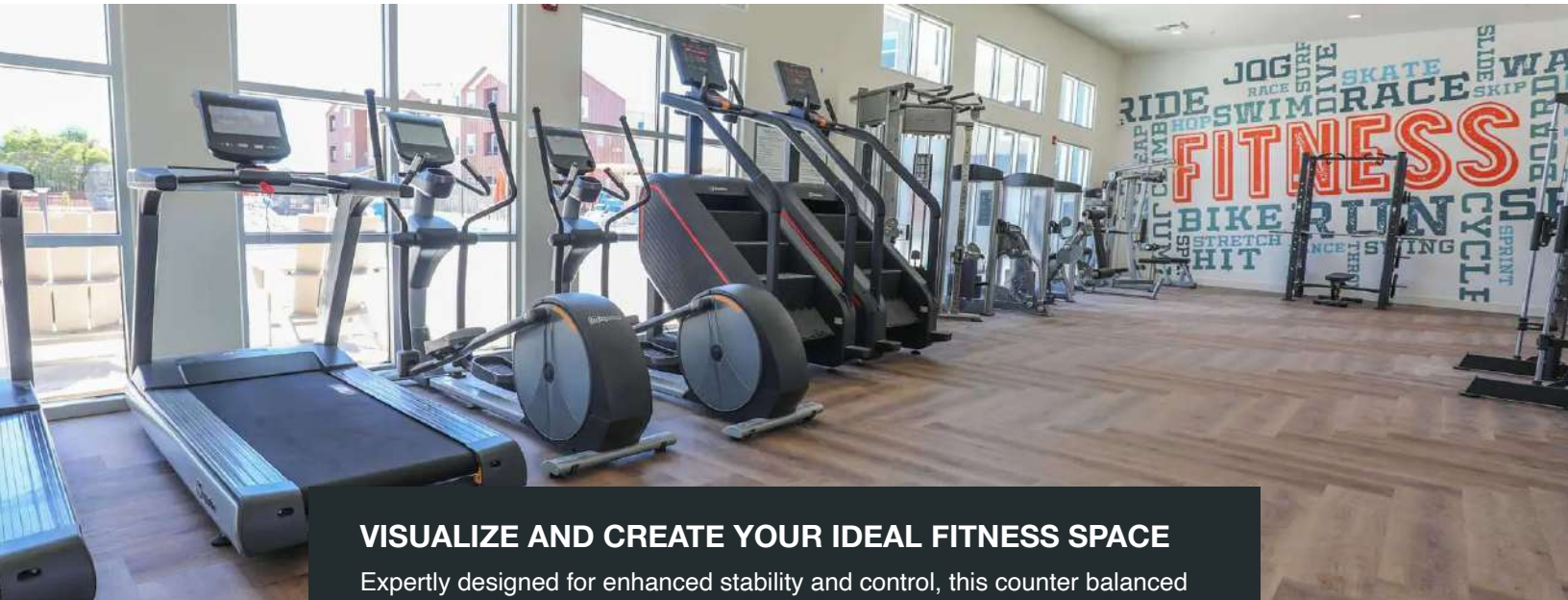

VISUALIZE AND CREATE YOUR IDEAL FITNESS SPACE

Expertly designed for enhanced stability and control, this counter balanced unit enables diverse workouts targeting various muscle groups.



Consultation and Space Assessment

Our experts engage with you to understand your fitness goals, preferences, and the specifications of your gym space. We consider everything from room dimensions to lighting, ensuring that every aspect of your space is assessed for optimal gym design.



Conceptualization and 3D Rendering

Post-consultation, our design team gets to work, transforming your vision into a detailed 3D model. This step is where your dream gym starts taking shape – from the placement of each machine to the overall layout and aesthetic.



Revision and Finalization

We collaborate closely with you to refine the design. This phase is all about tweaking and adjusting until everything feels just right. Whether it's changing equipment positions, altering color schemes, or adding additional features, we're committed to perfecting your space until it meets your absolute satisfaction.



Implementation Support

Once the final design is approved, we don't just leave you with a plan. Our team provides comprehensive support to bring the design to life. From recommending trusted installers to guiding you through the equipment setup, we ensure a smooth and hassle-free implementation of your home gym.

3D SPACE DESIGNS EXAMPLES

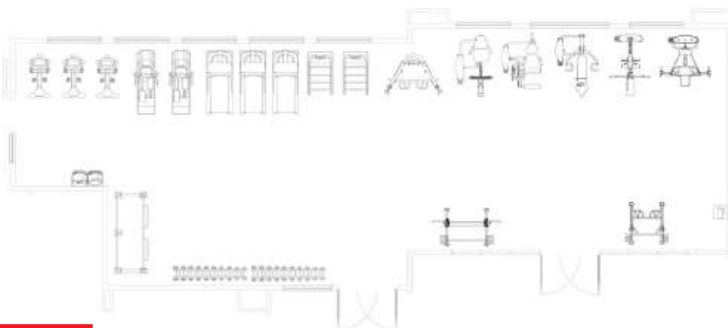
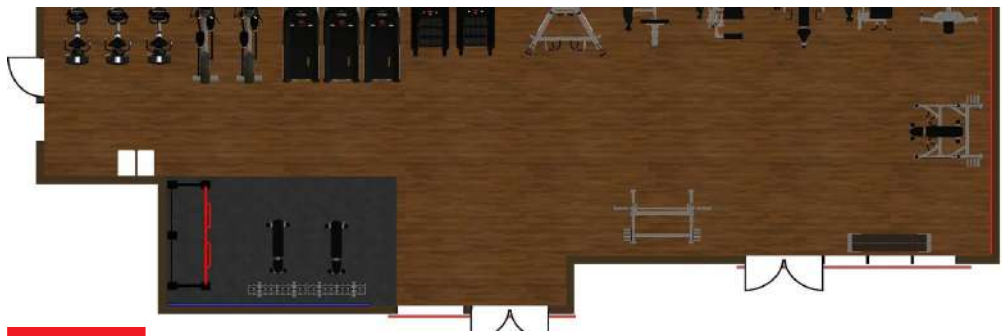
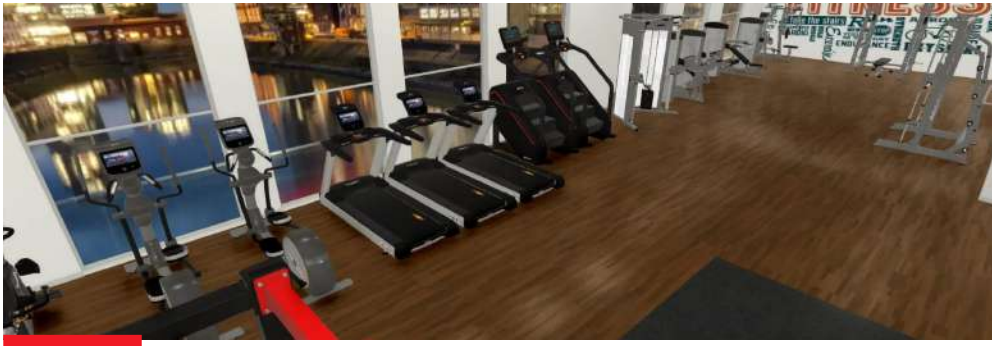

CUSTOM UPHOLSTERY AND PAINT SERVICE

CUSTOM COLOR



Electrostatic Powder Coating

Our equipment is coated with a state-of-the-art electrostatic powder coating, ensuring a durable, black matte or high-gloss silver finish that resists scratches, chipping and wear.



Environmentally Friendly Process

The powder coating technique is eco-conscious, producing minimal waste and using non-toxic materials, ensuring safety for your facility and the environment.



Wide Color Selection

Choose from our five standard colors or request a custom shade to align with your brand identity.

Available Colors

Matte Black

Charcoal

Platinum

Snow White

Fire Engine Red



UPHOLSTERY OPTIONS AND CUSTOM LOGOS

CUSTOM UPHOLSTERY



Personalized Aesthetics

Choose from five standard upholstery colors or request a custom shade to align with your facility's brand identity and create a cohesive, professional look.



Enhanced Branding

Add your facility's logo directly onto the upholstery for a polished professional appearance that reinforces your brand at every workout station.

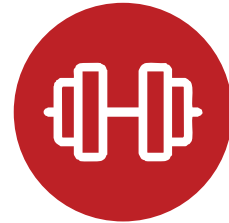

Durable Materials

Our upholstery is crafted from premium, high density foam and commercial-grade vinyl, ensuring maximum comfort, durability, and easy maintenance for high-traffic environments.

Available Colors

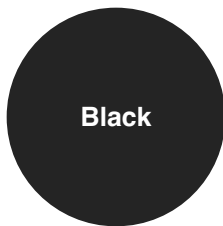

Black



Tan

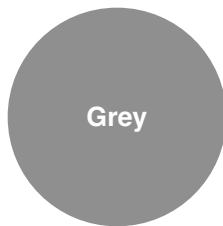

Grey

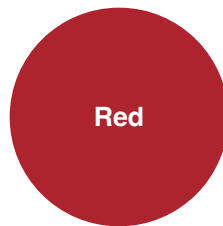

Red

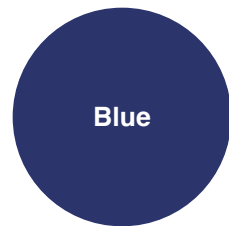

Blue



COLLINS AEROSPACE

SAN DIEGO, CA

BodyKore partnered with Collins Aerospace to remodel and modernize a 4,000-square-foot on-site fitness center serving more than 1,200 employees. The existing space was outfitted with a mix of aging equipment and needed a cohesive, professional solution built for daily, high-frequency use.

Using BodyKore's 3D facility planning process, the project moved from concept to completion with a clear focus on functional flow, equipment selection, and long-term durability. The redesigned gym now supports strength training, functional movement, and cardio conditioning in a well-organized, purpose-built environment.

Open 24/7 and free to employees, the updated fitness center gives staff a convenient way to manage stress, stay active, and train consistently without leaving the workplace. This project reflects BodyKore's approach to corporate wellness—thoughtful planning, commercial-grade equipment, and spaces designed to support both performance and everyday use over time.

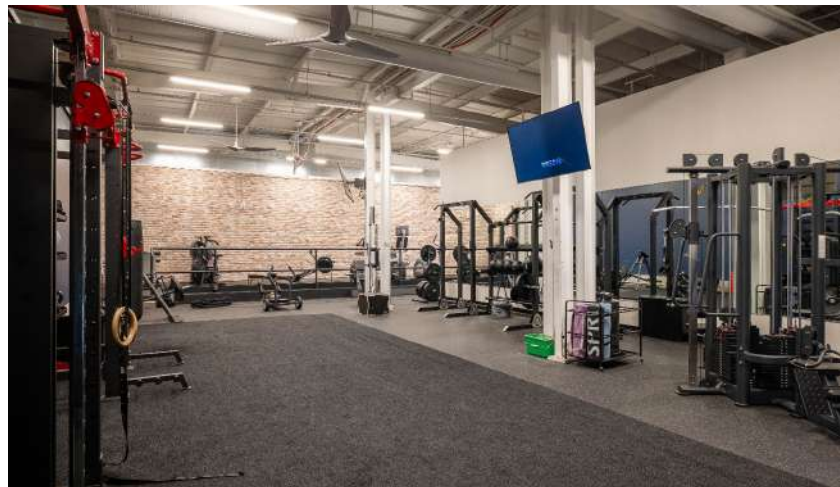

EDGE FITNESS

NEWPORT BEACH, CA

Edge Fitness was built with a clear purpose: create a training environment that goes beyond a typical gym. After 14 years in the fitness industry, owner Darron McIntosh designed Edge Fitness around four core principles—Energy, Drive, Grind, and Execution—and needed equipment that could support serious training without compromise.

BodyKore was selected to outfit the studio for its proven durability, smooth performance, and functional design. From initial planning through installation, BodyKore worked closely with the Edge Fitness team to ensure the space was equipped to handle daily high-intensity use while delivering a premium training experience clients immediately recognize and appreciate.

Today, Edge Fitness serves the Newport Beach community with a focused, performance-driven environment powered by BodyKore equipment—built to last and designed for results.



BOOTY BY BARBELLS

OCEANSIDE, CA

Booty by Barbells is revolutionizing group fitness at their new Oceanside location! They've elevated their training and programming with high-end, efficient setups that benefit both clients and trainers. Their full weight training area is equipped with 11 BodyKore Universal Trainers, offering incredible versatility in a compact space.



RETRO HOME GYM

CUSTOMIZED EQUIPMENT

Tucked inside a private Arizona estate, this custom garage gym by Growth Fitness Designs blends retro luxury with full commercial performance. Outfitted with BodyKore machines in matte black frames and custom tan upholstery, the space channels the bold personality of classic performance vehicles—think vintage Lamborghini meets high-end training environment. Charcoal black walls, sharp orange racing accents, and warm lighting set the tone for a training space that's equally refined and powerful.

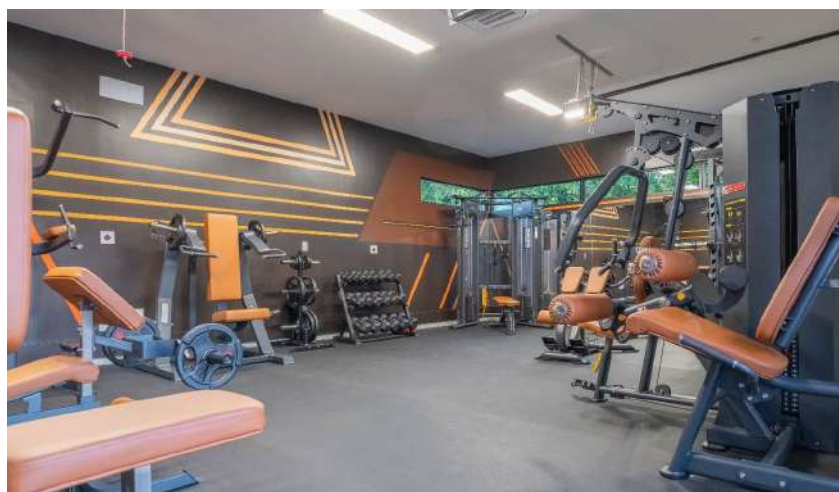
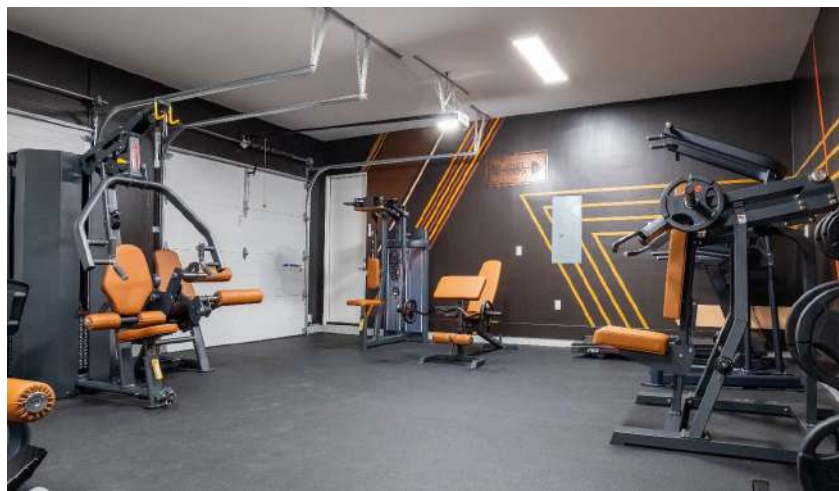



ISOLATION

S E R I E S

COMMERCIAL STRENGTH EQUIPMENT

Trusted by Pros Built for Everyone

Founded in 2005, BodyKore has a heritage of excellence, always exceeding our clients expectations. Known for superior quality and value, BodyKore products deliver the function, ease of use, biomechanics, and aesthetics you expect in premium strength products. From our NFL clients to literally hundreds of health clubs, fire and police stations, corporate wellness rooms, elite condominiums and country clubs, and more, our clients love and appreciate what Bodykore delivers. And, with a wide range of single station selectorized, dual function selectorized, functional trainers, plate loaded, and benches and racks, Bodykore has a solution for every need.

SELECTORIZED STRENGTH



Start-to-Finish
Diagrams



Sleek Weight Stack



Adjustable Roller
Pads



Premium Cushioned
Seats



Adjustable Seats



Sleek Urethane
Grips



Front and Rear
Shrouds



Cup Holders

Meet the Isolation Series: Where Precision Meets Performance

For fitness facilities where space and budget are key considerations, BodyKore's Isolation Series provides a comprehensive and efficient solution. This series maintains BodyKore's signature aesthetic appeal and robust construction while introducing innovative dual or multi-function stations.

Features:

- ◆ **Simple Diagrams. Smarter Workouts.**
A start-to-finish diagram simplifies the workout process, ensuring users of all experience levels can quickly learn and complete each exercise correctly.
- ◆ **Sleek Weight Stack with Easy Pin Adjustments**
The sleek black weight stack, facilitates easy adjustments through pin selection, whether standing or seated. The weight stack comes 220lb standard that is upgradeable to 340lbs.
- ◆ **Easily Adjustable Roller Pads**
When appropriate, roller pads are easily adjustable to provide maximum comfort and ergonomics.
- ◆ **Cushioned Seats Built for Comfort and Durability**
Our commercial grade upholstery delivers the durability that high use facilities demand while the high strength premium foam delivers the comfort that members want.
- ◆ **Adjustable Seats**
Machines can be easily adjusted by using the chrome push pin, giving users the flexibility to change the settings according to their body type.
- ◆ **Sleek Urethane Grips for Comfort and Control**
Various grips have a sleek design with durable urethane composite, reducing stress on contact points and enhancing comfort and grip reliability.
- ◆ **Premium Front and Rear Shrouds**
Front and rear shrouds prioritize safety while providing elegant aesthetics.
- ◆ **Bottle Holders Built Into Every Machine**
Isolation machines offer convenient and futuristic water bottle holders that double as versatile storage for phone, keys, wallet, and other personal items.

Single Movement



GR601

Selectorized Chest Press



GR602

Lat Pull Down



GR603

Selectorized Seated Row



GR604

Shoulder Press



GR605

Lateral Raise



GR606

Seated Leg Extension



GR607

Selectorized Leg Curl



GR608

Prone Leg Curl



GR609

Selectorized Bicep Curl

Single Movement



GR610

Tricep Extension



GR611

Selectorized Abdominal Crunch



GR612

Selectorized Back Extension



GR613

Selectorized Calf Extension



GR614

Seated Leg Press



GR615

Seated Dip



GR616

Selectorized Low Pull



GR617

Selectorized Rotary Torso



GR618

Selectorized Rear Kick

Single Movement



GR619

Selectorized Lat Pulldown



GR620

Pectoral Fly



GR621

Dual Axis Chest Press



GR624

Selectorized Hip Thrust



MX1161

**Functional Trainer -
Dual Adjustable Pulley**

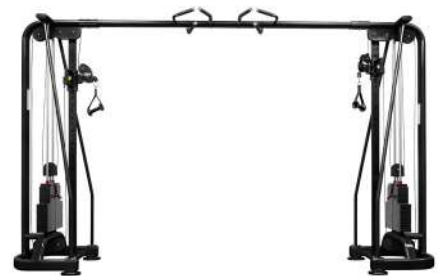

G502

Cable Crossover

Dual Movement



GR631

Leg Press/Calf Extension



GR632

Hip Adductor/Abductor



GR633

Pectoral Fly/Rear Delt



GR634
Bicep/Tricep



GR635
Selectorized Rotary Hip



GR636
Chin/Dip Assist



GR637
**Abdominal/Back Extension
Combo**



GR638
Lat Pulldown/Low Row



GR639
Leg Curl/Extension



GR640
Multi Press



GR643
Leg Extension/Leg Prone



SIGNATURE

SERIES

ENGINEERED FOR POWER & DURABILITY

Train Smarter, Push Harder

The Signature Series seamlessly blends classic movements with modern design, establishing it as a core feature in any wellness center. This series is the epitome of aesthetic allure paired with essential design, offering a compelling invitation for regular use. By revisiting the roots of strength training, the Signature Series surpasses basic weight training benchmarks with its exceptional quality in dumbbells, smith machines, and body weight training solutions.

Our top-of-the-line adjustable benches are designed for versatility, allowing precise angle adjustments to target specific upper body muscles effectively. The Signature Series' vibrant appearance, high gloss, and moisture-resistant qualities enhances both its visual appeal and durability.

POWER & STRENGTH

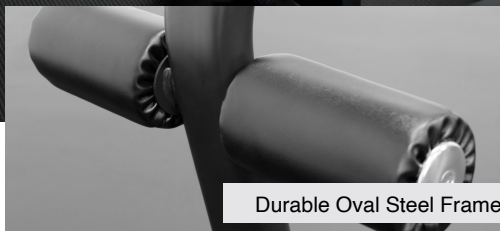

Durable Oval Steel Frame



Ultimate Comfort Cushion Seats



Adjustable Benches



Stable and Mobile Design



Easy-Move Integrated Handles



Biomechanically Correct Motion

Meet the Signature Series: Classic Movements, Modern Design

The Signature Series combines strength, comfort, and smart design, giving you durable equipment that looks great and makes every workout feel better.

Features:

- ◆ **Durable Oval Steel Frame**
Designed with ergonomically designed oval 11-gauge steel, this equipment offers unmatched durability and long-lasting reliability, even under the most intense workouts. Its signature sleek design adds a touch of modern sophistication to your gym space.
- ◆ **Ultimate Comfort Cushion Seats**
Crafted with high-strength, impact-resistant leather and dense foam, our cushion seats offer unparalleled comfort and durability.
- ◆ **Adjustable Benches**
Our benches feature a simple pin lock system, allowing adjustments from 180 to 90 degrees and various angles in between, designed for both versatility and space efficiency.
- ◆ **Stable and Mobile Design**
Equipped with rubber footings and wheels, the Signature Series ensures stability during use and easy mobility for convenient storage.
- ◆ **Easy-Move Integrated Handles**
The benches include integrated handles, facilitating effortless repositioning within the wellness center.
- ◆ **Biomechanically Correct Motion**
Biomechanically correct movement for a comfortable, focused workout.



G201
Flat Bench



G202
Utility Bench



G203
Multi Ab Bench



G205
Adjustable Ab Bench



G206
Adjustable Bench



G208
Ab Bench



G209
Stretch Bench



G210
Chin/Dip



G211
Utility Bench



G213
Sissy Squat



G214
Seated Row Bench



G216
Bridge Bench



G231
2 Tier Pro Dumbbell Rack

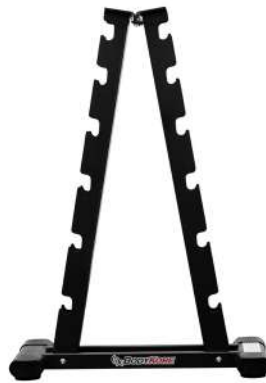

G233
Vertical Dumbbell Rack



G234
Olympic Weight Tree



G236
Pro Barbell Rack



G241
5-50lb Dumbbell Rack



G242
5-70lb Dumbbell Rack



G243

5-100lb Dumbbell Rack



G246

Accessory Storage Rack



G251

Olympic Bench Press



G252

Olympic Incline Press



G253

Olympic Decline Press



G254

Military Press



G255

Lunge Rack



G256

Full Squat Cage



G257

Preacher Curl



G271

Smith Machine



G272

Seated Calf Raise



G273

T-Bar Row



G274

Smith Machine/Free Weight



G277

45 Degree Leg Press



G278

Ab Slider



ELITE

SERIES

SMARTER. STRONGER. SLEEKER.

Built Strong. Designed Beautiful.

The Elite Series sets a new standard in fitness equipment design, combining state-of-the-art functionality with unmatched aesthetic appeal. Its sleek curves and high-quality finish transform any space it occupies. Building upon the foundation of our Signature line, the Elite Series introduces enhanced stylistic elements and superior hardware.

Manufactured from top-grade steel and backed by a lifetime warranty, the Elite Series exemplifies durability and sophistication. Unique features such as urethane mounting hooks, rubber step padding, stainless steel nuts and bolts, and extended mounting plates distinguish the Elite Series as a truly exceptional range of fitness equipment.

QUALITY AND ELEGANCE



Heavy-Duty Plate Storage



Floor-Safe Rubber Stability



Enduring Comfort Seats



Precision Adjustable Angles



Ultra-Durable Polyurethane Hooks



Supportive Foam Leg Rollers

Elite Series: Durability Backed by Design

Every detail of the Elite Series is designed with performance, comfort, and durability in mind. From storage to stability, each feature is built to elevate your workout experience.

Features:

- ◆ **Heavy-Duty Plate Storage**
Built for strength and durability, these stainless steel weight plate pegs boast a high weight capacity, ensuring secure and efficient storage for all your plates.
- ◆ **Floor-Safe Rubber Stability**
Designed to protect your floors from scratches and damage, the rubber feet add extra stability to your workout bench, preventing any unnecessary movement during use.
- ◆ **Enduring Comfort Seats**
Crafted with high-density foam and a wear-resistant surface, these seats are built to withstand the test of time, providing comfort and durability through countless workouts.
- ◆ **Precision Adjustable Angles**
Adaptable to various inclines and declines, the adjustable bench angles are perfect for any body type, ensuring maximum comfort and support during your exercises.
- ◆ **Ultra-Durable Polyurethane Hooks**
Engineered to withstand heavy usage, these polyurethane hooks are extremely durable and long lasting.
- ◆ **Supportive Foam Leg Rollers**
Foam leg rollers enhances stability and comfort, allowing you to perform exercises with ease and confidence.



CF2101
Flat Bench



CF2102
Utility Bench



CF2103
Adjustable Ab Crunch Bench



CF2104
Hyper Extension Bench



CF2105
Adjustable Decline Bench



CF2106
Adjustable Bench



CF2107
Vertical Knee Raise



CF2110
Chin Dip Tower



CF2134
Weight Plate Tree



CF2135
3 Tier Dumbbell Rack



CF2136
Barbell Rack



CF2151
Olympic Bench Press



CF2152
Olympic Incline Press



CF2153
Olympic Decline Press



CF2157
Seated Preacher Curl



CF2159
Lunge Rack



CF2160
Standing Biceps



CF2171
Smith Machine



CF2172
Calf Raise



CF2173
Standing T-Bar Row



CF2175
Hack Squat



CF8131
Glute Press



CF8133
Glute Rocker



CF8137
Pendulum Squat



FOUNDATION

SERIES

UNMATCHED STRENGTH. UNMATCHED DESIGN.

Raising the Bar on Strength Training

Raising the bar for functionality and dynamics, the Foundation Series connects Olympic style weightlifting with modern design. This series includes robust racks that serve as the cornerstone of power and strength training. These racks support multiple add-ons, such as a removable dip bar, reversible J-hooks, band pegs, and more, allowing for greater versatility in your training routine.

Designed for the seasoned lifter, the Foundation Series features a variety of cages, each promoting industrial-grade ergonomics and a free range of motion for safe, powerful workouts. It brilliantly balances strength and intelligence with its highly versatile designs aimed at maximizing workout efficiency. Enhanced stability is ensured by reinforced connecting plates, while the sleek black powder coating and stainless steel bolts maintain the series' polished look.

MAXIMIZE EVERY WORKOUT

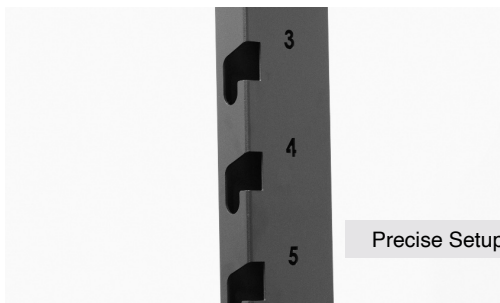
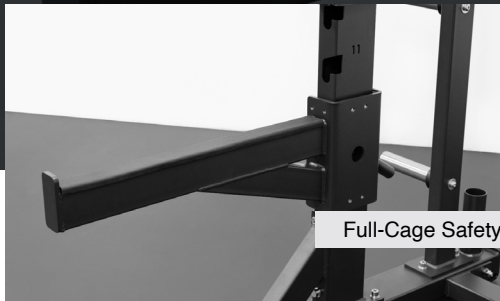

Foundation Series: Stronger Design. Smarter Training.

Built to deliver strength, safety, and versatility, the Foundation Series is packed with advanced features designed for serious lifters.

Features:

- ◆ **Full-Cage Safety**
Integrated safety spotters provide reliable protection during squats, presses, and rack pulls.
- ◆ **Precise setup**
Thirteen numbered mounting positions allow fast, repeatable adjustments for multiple users.
- ◆ **Training Versatility**
Dual-position J-hooks and a multi-grip pull-up bar support a wide range of barbell and bodyweight movements.
- ◆ **Organized Storage**
Ten integrated bar pegs keep plates accessible and off the floor, improving workflow and safety.
- ◆ **Commercial Stability**
Wide stance and heavy-duty construction minimize movement under heavy loads.



G700-P

Wooden Lifting Platform



G701

Half Rack



G702

Foundation Series Full Cage



G704

Commercial Adjustable Bench



G706

Customizable Commercial Half Rack



G707

Half Rack (3"x3")



GR707-SR

Accessory Storage Rack



VFCR1701A

Linx Rack- Single Bay



VFCR1701D

Storage Rack

Attachments



G701-D

Dip Bar for G701 + G702



G701-LM

Landmine for G701 + G702



G701-JH

Double Sided J Hooks
for G701 + G702



G701-SS

Double Sided J Hooks for
G701 + G702



G706-D

Dip Bar for G706



G706-SS

Split Attachment
for G706

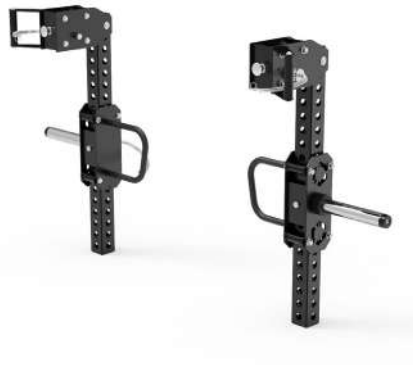

G706-JA

Jammer Arms for G706



G706-JH

J Hooks for G706

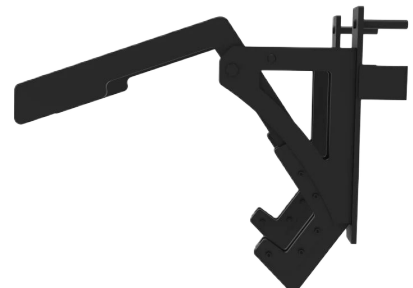

G706-ML

Monolift Arms for G706



PRO PERFORMANCE STORAGE SYSTEM

MODULAR STORAGE THAT GROWS WITH YOUR GYM.

Maximum Efficiency

Designed for commercial facilities and serious training environments, the Pro Performance Storage System is a modular solution that keeps strength zones organized and efficient. Built for gyms that demand durability and adaptability, this system delivers professional-grade storage that supports high-volume use without wasted space or clutter.

Ideal for commercial gyms, performance centers, and studio environments that prioritize space efficiency and organization. Also suited for premium home gyms requiring professional storage capacity and clean, accessible layout.

Constructed from commercial-grade 11-gauge steel, the Pro Performance Storage System is engineered for long-term stability and strength. Its modular framework resists flex and corrosion while maintaining a sleek, professional appearance suitable for any training environment.

BUILT FOR THE GRIND

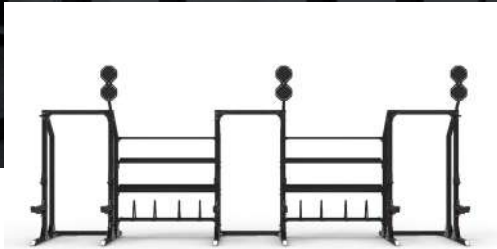

Fully Customizable Layouts



Industrial-Strength Stability

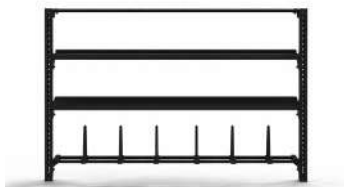

Seamless Training Flow



Total Equipment Organization



Expandable Design

Pro Performance Storage System: No Wasted Space. No Clutter. Just Performance.

The Pro Performance Storage System is more than storage — it's a foundation for organized, high-performance training spaces.

Features:

- ◆ **Fully Customizable Layouts**
Modular configuration allows customization across training spaces.
- ◆ **Industrial-Strength Stability**
Supports over 1,000 lbs. of stored weight with a heavy-duty 11-gauge steel frame.
- ◆ **Seamless Training Flow**
Integrated half racks with four-tier storage for seamless workout flow.
- ◆ **Total Equipment Organization**
Accommodates bumper plates, kettlebells, medicine balls, foam rollers, and more.
- ◆ **Expandable Design**
Additional stations can be added to either side as needs grow.



G707
Half Rack (3"x3")

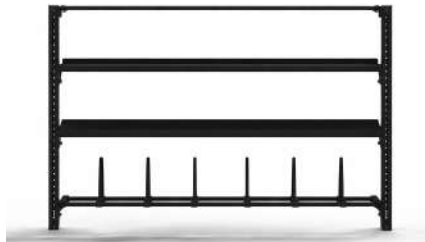

G707-C
Center Storage for G707



G707-E
End Frame for G707



G707-SS
Split Squat Attachment



G707-MB
Monkey Bar



G707-WP
Weight Peg for Olympic Plates



G707-WB
Wall Ball Target



G707-LM
Land Mine Attachment



G707-BP
Band Peg Attachment



G707-DB
Dip Bar Attachment



G707-RA
Rope Anchor Attachment



ALLIANCE

SERIES

THE FUTURE OF FITNESS EQUIPMENT

Multi-Function Cable Systems

The Alliance Series merges ingenious design with versatile capabilities, perfectly aligning with the biomechanics needed in any wellness facility. This series embodies the essence of a fully-equipped fitness center while minimizing space usage typically associated with large, bulky equipment. By optimizing the spatial footprint, Alliance emphasizes both space efficiency and multi-functionality.

With its aesthetically pleasing and contemporary design, the Alliance Series fosters an inviting, social atmosphere. It encourages interaction among gym members, whether in group classes or paired exercises, as they pursue their individual fitness objectives.

STYLE MEETS STRENGTH



Silent Stack System



Stable Non-Slip Foot Platforms



220lb Standard Stack, Upgradeable to 340lbs



Heavy-Duty Imported Steel Cable



11-Gauge Steel Frame for Lasting Strength



Secure Aluminum-Collared Grips



Protective Rubber Feet for Stability



220lb Weight Stacks at Every Station

Alliance Series: Built for Connection and Performance

The Alliance Series is designed to bring maximum versatility into a compact, modern package. By merging sleek aesthetics with space-saving innovation, it delivers the feel of a fully equipped fitness center without the bulk of traditional machines. Built for efficiency and interaction, Alliance creates an inviting environment where members can train, connect, and push their limits—all in less space.

Features:

- ◆ **Silent Stack System**
Multipurpose stack weight system is smooth and soundless as users engage simultaneously.
- ◆ **Stable Non-Slip Foot Platforms**
Two large non-slip foot platforms designed for stability and proper form.
- ◆ **220lb Standard Stack, Upgradeable to 340lbs**
The sleek black weight stack, facilitates easy adjustments through pin selection, whether standing or seated. The weight stack comes 220lb standard that is upgradeable to 340lbs.
- ◆ **Heavy-Duty Imported Steel Cable**
The imported steel cable is $\Phi 4.8\text{mm}$, has 12000N breaking strength, and has passed fatigue test of 100 million times.
- ◆ **11-Gauge Steel Frame for Lasting Strength**
The 11-gauge steel frame provides exceptional structural integrity for long-lasting durability and stability.
- ◆ **Secure Aluminum-Collared Grips**
Grips with aluminum collars ensure a secure grip, preventing slipping during use.
- ◆ **Protective Rubber Feet for Stability**
Durable rubber feet protect the frame's base and keep the machine stable, preventing unwanted movement.
- ◆ **220lb Weight Stacks at Every Station**
Each station includes 220 lbs of weight stacks for a versatile and challenging workout.



GM5001

Cable Crossover



GM5003

Four Station/Position



GM5013

**Four Station/Position
w/ Chin Dip**



GM5005

Five Station/Position



GM5015

**Five Station/Position
w/ Chin Dip**



GM5004

Eight Station/Position



GM5014

**Eight Station/Position
w/ Chin Dip**



PC1801

Dual Cable Cross



MX1162-MF

Smith/Dual Adjustable Pulley



MTI4201

Multi-Gym Chest Press/Lat Pull Down



MTI4001

2 Station Multi-Gym - Chest/Back, Leg Extension/Curl



MTI4002

2 Station Multi-Gym - Chest/Back, Leg Press



MTI4003

2 Station Multi-Gym - Chest/Back, Pec/Fly



MTI4005

3 Station Multi-Gym - Chest/Back, Leg Extension, Leg Press



MTI4007

3 Station Multi-Gym - Chest/Back, Leg Extension, Pec/Fly



MTI4009

4 Station Multi-Gym - Chest, Leg Ext, Leg Press, Column Pulley



MTI4010

4 Station Multi-Gym - Chest, Leg Ext, Leg Press, Pec/Fly



MTI4016

5 Station Multi-Gym - Chest, Leg Ext, Leg Press, Cable Cross



UNIVERSAL

SERIES

STRENGTH, VERSATILITY, EFFICIENCY

All-in-One Training Systems

The Universal Series is a next-generation line of strength training machines designed to bring versatility, performance, and efficiency into one cohesive system. Each piece in the series is engineered to complement the body's natural movement, providing a training experience that feels both powerful and intuitive.

With space-efficient designs, the Universal Series condenses multiple workout stations into streamlined units that accommodate a wide variety of training styles — from free weights and cable resistance to bodyweight movements and heavy compound lifts. Every machine in the series is built with premium steel frames rated for over 1,000 lbs, smooth guide rails for consistent motion, and a thermo-setting powder-coated finish that delivers durability with a modern look.

SPACE-SAVING DESIGN. FULL-SPECTRUM TRAINING.

Meet the Universal Series: The Future of Training

The Universal Series is designed with unmatched versatility in mind, offering a full lineup of attachments and features that adapt to every style of training. Here's what makes it the ultimate all-in-one system:

Features:



Dip Bar



Inverted Leg Press



J Hooks



Jammer Arms



Leg Extension/
Curl Seat



Safety Spotter
Arms



Dual Pulley
System



Landmine



Lat Pull Down
Seat



Low Row
Footplate



Isolateral Leg
Press Attachment
MX1183



Attachment
Diagram
MX1185



Back Mounted
Accessory Rack
MX1186



Multi-Flight
Attachment
MX1189



Universal Trainer Side
Mount Attachment Rack
MX1178



Universal
Storage Rack
MX1191



Dip Bar/Knee
Raise
MX1155



Lat Seat w. Leg
Ext/Curl
MX1188

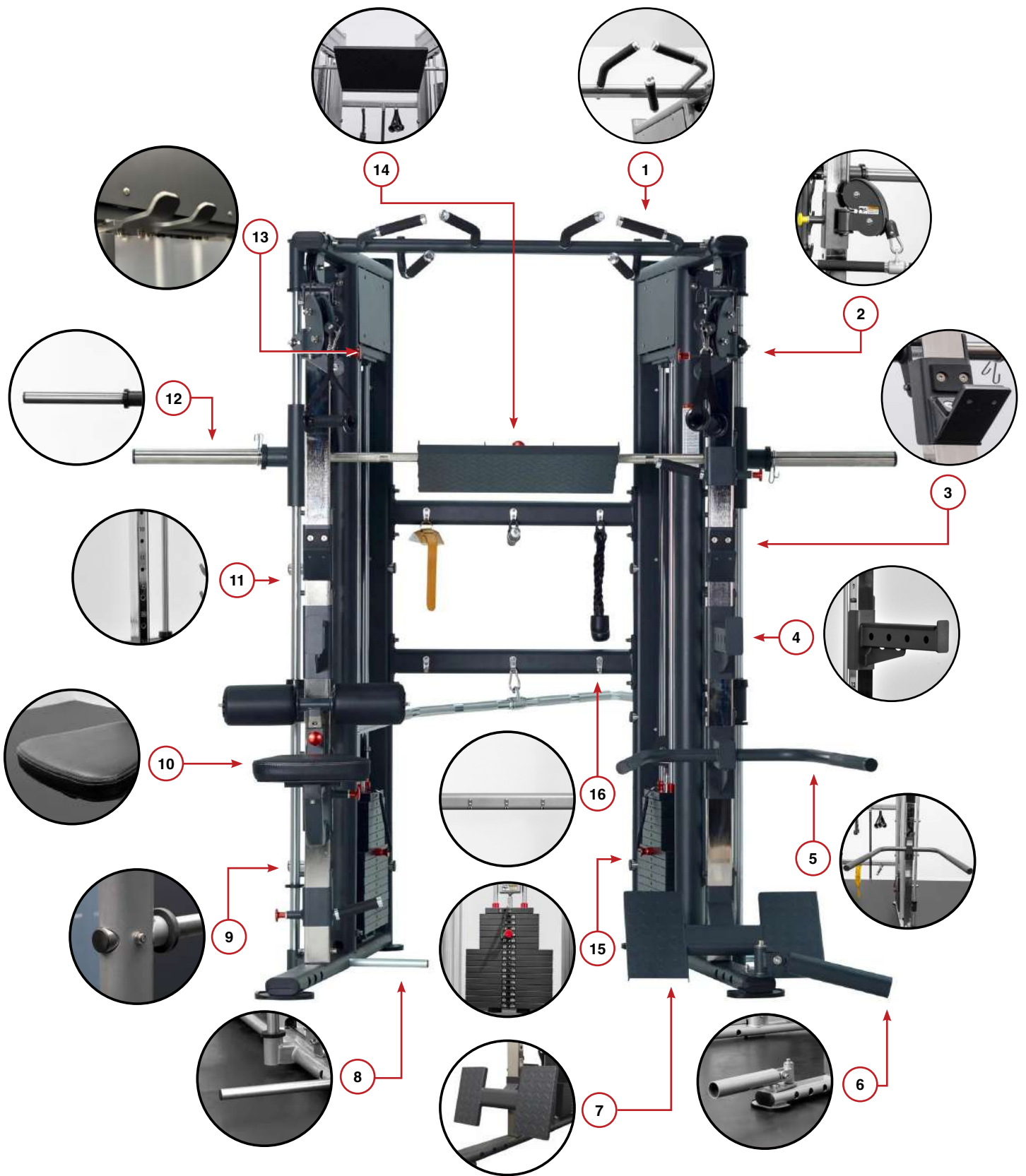

1. Multi-Grip Pull-Up Bar	5. Dip Bar Attachment	9. Olympic Plate Storage	13. Bar Storage
2. Sliding Pulley Arms	6. Land Mine	10. Lat Pull-Down Seat	14. Inverted Leg Press Attachment
3. J Hooks Attachments	7. Low Bar Footplate	11. Number Column	15. Dual Pulley System
4. Safety Spotter Attachment	8. Band Pegs	12. Smith Machine	16. Accessories Hooks



MX1162
Universal Trainer



MX1162-MF
MF Smith/Daps



MX1161FX
Dynamic Trainer



MX1174
**Universal 1 - Single Station
Adjustable Pulley System**



MX1179
Universal FID Bench V2



MX1167
**Leg Extension/Leg Curl
Attachment**



MX1168
Preacher Curl Attachment



MX1151
Multi Flexion Bench



STACKED

SERIES

STRENGTH WITHOUT COMPROMISE

Redefining Plate-Loaded Training

The Stacked Series ingeniously blends the free-weight essence of the Foundation Series with the targeted motion of the Isolation Series. This plate-loaded lineup is designed for independent arm movements, enabling balanced muscle growth and unilateral strength training. The Stacked series offers a harmonious combination of power and precision, ensuring a safe and effective strength-building journey.

Showcasing top-tier craftsmanship, the series features precise aluminum alloy end caps, visually appealing cushion designs, and a sleek glossy finish. Its robust construction supports heavy weightlifting, complemented by non-slip grip handles for secure and comfortable training, even under significant loads.

STYLE MEETS STRENGTH



Ergonomic Non-Slip Handles



Uniform Seat Height Adjustment



Refined Craftsmanship



Comfort-Focused Cushions



Guided Motion and Safety Locking Points



Integrated Weight Storage and Plate-Loading Pegs



Precision-Engineered Linear Guide Rod



Industrial Rated Bearings

Meet the Stacked Series:

Built for Strength. Designed for You.

The Stacked Series is built with precision engineering and thoughtful design details that elevate both performance and experience. Every feature is crafted to deliver comfort, safety, and durability—ensuring each workout is as effective as it is reliable.

Features:

◆ Ergonomic Non-Slip Handles

Designed to prevent hand slippage under heavy loads, enhancing grip strength. Each handle is complemented with high-precision aluminum alloy end caps, showcasing its superior quality.

◆ Uniform Seat Height Adjustment

Allows users to easily find and set their preferred seat height across all Stacked Series machines, ensuring a consistent workout experience.

◆ Refined Craftsmanship

Each piece features precise aluminum alloy end caps, elegant bolts, and a smooth glossy finish, highlighting the series' attention to detail and quality.

◆ Comfort-Focused Cushions

Crafted from high-density polymeric sponge, these cushions conform to the human body, providing both stability and comfort during intense workouts.

◆ Guided Motion and Safety Locking Points

This provides a secure workout experience, eliminating the need for a spotter.

◆ Integrated Weight Storage and Plate-Loading Pegs

This allows convenient organization and easy access.

◆ Precision-Engineered Linear Guide Rod

This ensures smooth and consistent motion.

◆ Industrial Rated Bearings

Sealed bearings at all pivot points.



GR801

Plate Loaded Chest Press



GR802

Plate Loaded Row



GR803

Plate Loaded Shoulder Press



GR804

Plate Loaded Incline Chest Press



GR805

Wide Chest Press



GR806

Plate Loaded Pull Down



GR807

Stacked Low Row



GR808

Squat Press



GR809

Standing Calf Raise



GR810
Rear Kick



FL1801
Isolateral Leg Press



FL1802
Lat Pulldown



FL1803
Seated Row



FL1804
Chest Press



FL1805
Seated Dip



FL1806
Super Squat



FL1808
Prone Leg Curl



FL1809
Isolateral Horizontal Swing
Leg Press



FL1810
Leg Extension



FL1811
Adjustable Hack Squat



FL1814
Plate Loaded Chest Pullover



FL1816
Bench Press



FL1817
Shoulder Press



FL1823
Unilateral Bicep Curl



FL1825
Glute Ham Developer



FL1834
Belt Squat



PUSH SLED

THE “TESLA” OF FITNESS SLEDS

Train Smarter. Push Harder.

Revolutionizing traditional sled training, the Smart Sled Pro is designed for athletes seeking a comprehensive workout challenge. It activates every muscle group, enhancing power, strength, agility, and endurance. This cutting-edge sled stands out with its patented app-controlled features and live data feedback, allowing for a more analytical approach to training. It supports multi-planar movements, a range of training modes, and offers motorized resistance that surpasses conventional sleds by up to 3x's!!! The Smart Sled Pro is intelligently designed to help athletes and fitness enthusiasts train smarter and outperform those using yesterday's sled, positioning it as the most advanced sled on the market.

REVOLUTIONIZE YOUR TRAINING



Permanent Magnetic Digital Resistant Motors



Ergonomic Removable Handles



Caster Wheels

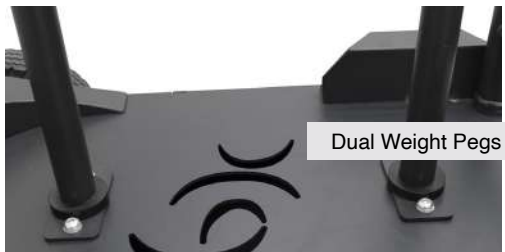

Dual Weight Pegs



All-Terrain Tires with High-Quality Alloy Wheels



Tow Hook

Meet the Smart Sled Pro: **Smart Resistance. Smarter Results**

Every feature is built to enhance training efficiency, mobility, and control—making it the ultimate tool for athletes who demand more from their workouts. Key features include:

Features:

- ◆ Permanent Magnetic Digital Resistant Motors
- ◆ Ergonomic Removable Handles
- ◆ Caster Wheels
- ◆ Dual Weight Pegs
- ◆ All-Terrain Tires with High-Quality Alloy Wheels
- ◆ Tow Hook



BK-SS01

Smart Sled Pro



MFPS-01

Magforce Power Sled

Isolation Series (Single Movement)

CODE	PRODUCT NAME	Dimensions (IN)			Dimensions (CM)			Weight (lbs)	Weight (kg)	Weight Stack (lbs)	Weight Stack (kg)
		L	W	H	L	W	H				
GR601	Selectorized Chest Press	60	49	65	152.4	124.5	165.1	511	231.8	220; Upgradeable to 340	99.8; Upgradeable to 154.2
GR602	Lat Pull Down	63	58	75	160	147.3	190.5	540	244.9	220; Upgradeable to 340	99.8; Upgradeable to 154.2
GR603	Selectorized Seated Row	62	42	65	157.5	106.7	165.1	489	221.8	220; Upgradeable to 340	99.8; Upgradeable to 154.2
GR604	Shoulder Press	66	59	65	167.6	149.9	165.1	531	240.9	220; Upgradeable to 340	99.8; Upgradeable to 154.2
GR605	Lateral Raise	46	50	65	116.8	127	165.1	511	231.8	220; Upgradeable to 340	99.8; Upgradeable to 154.2
GR606	Seated Leg Extension	69	49	65	175.3	124.5	165.1	544	246.8	220; Upgradeable to 340	99.8; Upgradeable to 154.2
GR607	Selectorized Leg Curl	69	49	65	175.3	124.5	165.1	579	262.6	220; Upgradeable to 340	99.8; Upgradeable to 154.2
GR608	Prone Leg Curl	60	46	65	152.4	116.8	165.1	518	235	220; Upgradeable to 340	99.8; Upgradeable to 154.2
GR609	Selectorized Bicep Curl	44	47	65	111.8	119.4	165.1	480	217.7	220; Upgradeable to 340	99.8; Upgradeable to 154.2
GR610	Tricep Extension	35	47	65	88.9	119.4	165.1	464	210.5	220; Upgradeable to 340	99.8; Upgradeable to 154.2
GR611	Selectorized Abdominal Crunch	46	45	65	116.8	114.3	165.1	498	225.9	220; Upgradeable to 340	99.8; Upgradeable to 154.2
GR612	Selectorized Back Extension	46	45	65	116.8	114.3	165.1	498	225.9	220; Upgradeable to 340	99.8; Upgradeable to 154.2
GR613	Selectorized Calf Extension	47	43	68	119.4	109.2	172.7	493	223.6	220; Upgradeable to 340	99.8; Upgradeable to 154.2
GR614	Seated Leg Press	70	44	73	177.8	111.8	185.4	687	311.6	220; Upgradeable to 340	99.8; Upgradeable to 154.2
GR615	Seated Dip	63	58	75	160	147.3	190.5	543	246.3	220; Upgradeable to 340	99.8; Upgradeable to 154.2
GR616	Selectorized Low Pull	70	43	73	177.8	109.2	185.4	462	209.6	220; Upgradeable to 340	99.8; Upgradeable to 154.2
GR617	Selectorized Rotary Torso	43	46	65	109.2	116.8	165.1	511	231.8	220; Upgradeable to 340	99.8; Upgradeable to 154.2
GR618	Selectorized Rear Kick	72	41	73	182.9	104.1	185.4	500	226.8	220; Upgradeable to 340	99.8; Upgradeable to 154.2
GR619	Selectorized Lat Pulldown	47	47	88	119.4	119.4	223.5	449	203.7	220; Upgradeable to 340	99.8; Upgradeable to 154.2
GR620	Pectoral Fly	64	46	77	162.6	116.8	195.6	511	231.8	220; Upgradeable to 340	99.8; Upgradeable to 154.2
GR621	Dual Axis Chest Press	49	61	71	124.5	154.9	180.3	428	194.1	220; Upgradeable to 340	99.8; Upgradeable to 154.2
GR624	Selectorized Hip Thrust	65	50	65	165.1	127	165.1	490	222.3	220; Upgradeable to 340	99.8; Upgradeable to 154.2
MX1161	Functional Trainer - Dual Adjustable Pulley	70	48	89	177.8	121.9	226.1	843	382.4	220*2; Upgradeable to 340	99.8*2; Upgradeable to 154.2
G502	Cable Crossover	151	28	91	383.5	71.1	231.1	969	439.5	220*2; Upgradeable to 340*2	99.8*2; Upgradeable to 154.2*2

COMMERCIAL STRENGTH WARRANTY (NORTH AMERICA ONLY)

Frame (Not Coatings)**/ Weight Stacks / Pulleys / Pivot Bearings	10 Years	Cables / Pulleys / Parts / Hardware	5 Years
Upholstery / Springs / Grips / Paint / Attachments	1 Year	Other Items Not Specified	3 Years
Accessories	6 Months		

RESIDENTIAL STRENGTH WARRANTY (NORTH AMERICA ONLY)

Frame (Not Coatings)**/ Cables & Pulleys / Weight Stacks	Lifetime	Attachments / Upholstery / Paint	2 Years
--	----------	----------------------------------	---------

** Frame is defined as the welded-metal base of the unit and does not include removable parts

Note: all specifications are subject to change without notice. Actual products may differ from those pictured in this catalog

Isolation Series (Dual Movement)

CODE	PRODUCT NAME	Dimensions (IN)			Dimensions (CM)			Weight (lbs)	Weight (kg)	Weight Stack (lbs)	Weight Stack (kg)
		L	W	H	L	W	H				
GR631	Leg Press/Calf Extension	68	40	65	172.7	101.6	165.1	582	264	220; Upgradeable to 340	99.8; Upgradeable to 154.2
GR632	Hip Adductor/Abductor	70	39	65	177.8	99.1	165.1	551	249.9	220; Upgradeable to 340	99.8; Upgradeable to 154.2
GR633	Pectoral Fly/Rear Delt	57	56	77	144.8	142.2	195.6	502	227.7	220; Upgradeable to 340	99.8; Upgradeable to 154.2
GR634	Bicep/Tricep	42	48	65	106.7	121.9	165.1	513	232.7	220; Upgradeable to 340	99.8; Upgradeable to 154.2
GR635	Selectorized Rotary Hip	60	33	65	152.4	83.8	165.1	526	238.6	220; Upgradeable to 340	99.8; Upgradeable to 154.2
GR636	Chin/Dip Assist	55	49	90	139.7	124.5	228.6	515	233.6	220; Upgradeable to 340	99.8; Upgradeable to 154.2
GR637	Abdominal/Back Extension Combo	46	45	65	116.8	114.3	165.1	504	228.6	220; Upgradeable to 340	99.8; Upgradeable to 154.2
GR638	Lat Pulldown/Low Row	69	49	94	175.3	124.5	238.8	487	220.9	220; Upgradeable to 340	99.8; Upgradeable to 154.2
GR639	Leg Curl/Extension	68	50	65	172.7	127	165.1	582	264	220; Upgradeable to 340	99.8; Upgradeable to 154.2
GR640	Multi Press	74	51	64	188	129.5	162.6	540	244.9	220; Upgradeable to 340	99.8; Upgradeable to 154.2
GR643	Leg Extension/Leg Prone	61	44	65	154.9	111.8	165.1	507	230	220; Upgradeable to 340	99.8; Upgradeable to 154.2

COMMERCIAL STRENGTH WARRANTY (NORTH AMERICA ONLY)

Frame (Not Coatings)**/ Weight Stacks / Pulleys / Pivot Bearings	10 Years	Cables / Pulleys / Parts / Hardware	5 Years
Upholstery / Springs / Grips / Paint / Attachments	1 Year	Other Items Not Specified	3 Years
Accessories	6 Months		

RESIDENTIAL STRENGTH WARRANTY (NORTH AMERICA ONLY)

Frame (Not Coatings)**/ Cables & Pulleys / Weight Stacks	Lifetime	Attachments / Upholstery / Paint	2 Years
--	----------	----------------------------------	---------

** Frame is defined as the welded-metal base of the unit and does not include removable parts
 Note: all specifications are subject to change without notice. Actual products may differ from those pictured in this catalog

Signature Series

CODE	PRODUCT NAME	Dimensions (IN)			Dimensions (CM)			Weight (lbs)	Weight (kg)
		L	W	H	L	W	H		
G201	Flat Bench	53	24	16	134.6	61	40.6	73	33.1
G202	Utility Bench	53	26	43	134.6	66	109.2	90	40.8
G203	Multi Ab Bench	55	23	36	140	59	91	122	55.5
G205	Adjustable Ab Bench	60	23	31	152.4	58.4	78.7	106	48.1
G206	Adjustable Bench	54	23	49	137.2	58.4	124.5	101	45.8
G208	Ab Bench	60	36	38	152.4	91.4	96.5	149	67.6
G209	Stretch Bench	52	21	38	132.1	53.3	96.5	93	42.2
G210	Chin/Dip	48	52	88	120.7	131	223.6	171	77.5
G211	Utility Bench	25	31	36	63	79.6	92.4	79	36
G213	Sissy Squat	42	24	17	106.7	61	43.2	47	21.3
G214	Seated Row Bench	27	48	37	68.6	121.9	94	77	34.9
G216	Bridge Bench	30	24	17	76.2	61	43.2	83	37.6
G231	2 Tier Pro Dumbbell Rack	89	24	33	226.1	61	83.8	143	64.9
G233	Vertical Dumbbell Rack	32	16	45	81.3	40.6	114.3	46	20.9
G234	Olympic Weight Tree	30	26	51	76.2	66	129.5	62	28.1
G236	Pro Barbell Rack	30	35	53.5	76.2	88.9	135.9	62	28.1

COMMERCIAL STRENGTH WARRANTY (NORTH AMERICA ONLY)

Frame (Not Coatings)**/ Weight Stacks / Pulleys / Pivot Bearings	10 Years	Cables / Pulleys / Parts / Hardware	5 Years
Upholstery / Springs / Grips / Paint / Attachments	1 Year	Other Items Not Specified	3 Years
Accessories	6 Months		

RESIDENTIAL STRENGTH WARRANTY (NORTH AMERICA ONLY)

Frame (Not Coatings)**/ Cables & Pulleys / Weight Stacks	Lifetime	Attachments / Upholstery / Paint	2 Years
--	----------	----------------------------------	---------

** Frame is defined as the welded-metal base of the unit and does not include removable parts
 Note: all specifications are subject to change without notice. Actual products may differ from those pictured in this catalog

Signature Series

CODE	PRODUCT NAME	Dimensions (IN)			Dimensions (CM)			Weight (lbs)	Weight (kg)
		L	W	H	L	W	H		
G241	5-50lb Dumbbell Rack	52	20	35	132.1	50.8	88.9	95	43.1
G242	5-70lb Dumbbell Rack	68	20	35	172.7	50.8	88.9	121	54.9
G243	5-100lb Dumbbell Rack	102	20	35	259.1	50.8	88.9	161	73
G246	Accessory Storage System	90	26	50	228.6	66	127	560	254
G251	Olympic Bench Press	55	51	52	139.7	129.5	132.1	179	81.2
G252	Olympic Incline Press	54	51	62	137.2	129.5	157.5	203	92.1
G253	Olympic Decline Press	62	51	52	157.5	129.5	132.1	201	91.2
G254	Military Press	69	65	70	175.3	165.1	177.8	282	127.9
G255	Lunge Rack	62	64	74	157.5	162.6	188	271	122.9
G256	Full Squat Cage	64	66	89	162.6	167.6	226.1	357	161.9
G257	Preacher Curl	34	41	42	86.4	104.1	106.7	97	44
G271	Smith Machine	94	52	93	238.8	132.1	236.2	421	191
G272	Seated Calf Raise	51	28	35	130.8	72	90	91	41.5
G273	T Bar Row	29	61	24	73.7	154.9	61	97	44
G274	Smith Machine/Free Weight	871	524	891	2212	1330	2262	422	191.5
G277	45 Degree Leg Press	64	83	47	162.6	210.8	119.4	485	220
G278	Ab Slider	82	35	59	208.3	88.9	149.9	229	103.9

COMMERCIAL STRENGTH WARRANTY (NORTH AMERICA ONLY)

Frame (Not Coatings)**/ Weight Stacks / Pulleys / Pivot Bearings	10 Years	Cables / Pulleys / Parts / Hardware	5 Years
Upholstery / Springs / Grips / Paint / Attachments	1 Year	Other Items Not Specified	3 Years
Accessories	6 Months		

RESIDENTIAL STRENGTH WARRANTY (NORTH AMERICA ONLY)

Frame (Not Coatings)**/ Cables & Pulleys / Weight Stacks	Lifetime	Attachments / Upholstery / Paint	2 Years
--	----------	----------------------------------	---------

** Frame is defined as the welded-metal base of the unit and does not include removable parts

Note: all specifications are subject to change without notice. Actual products may differ from those pictured in this catalog

Elite Series

CODE	PRODUCT NAME	Dimensions (IN)			Dimensions (CM)			Weight (lbs)	Weight (kg)
		L	W	H	L	W	H		
CF2101	Flat Bench	25	55	19	63.5	139.7	48.3	64	29
CF2102	Utility Bench	51	31	39	129.5	78.7	99.1	86	39
CF2103	Adjustable Ab Crunch Bench	60	33	44	152.4	83.8	111.8	106	48.1
CF2104	Hyper Extension Bench	33	49	38	83.8	124.5	96.5	121	54.9
CF2105	Adjustable Decline Bench	61	33	20	154.9	83.8	50.8	110	49.9
CF2106	Adjustable Bench	31	52	19	78.7	132.1	48.3	99	44.9
CF2107	Vertical Knee Raise	31	49	63	78.7	124.5	160	187	84.8
CF2110	Chin Dip Tower	50	49	87.5	127	124.5	222.3	238	108
CF2134	Weight Plate Tree	51	51	49	129.5	129.5	124.5	90	40.8
CF2135	3 Tier Dumbbell Rack	90	31	37	227.6	78	94.5	220	99.8
CF2136	Barbell Rack	35	35	53	88.9	88.9	134.6	176	79.8
CF2151	Olympic Bench Press	51	55	52	129.5	139.7	132.1	220	99.8

COMMERCIAL STRENGTH WARRANTY (NORTH AMERICA ONLY)

Frame (Not Coatings)**/ Weight Stacks / Pulleys / Pivot Bearings	10 Years	Cables / Pulleys / Parts / Hardware	5 Years
Upholstery / Springs / Grips / Paint / Attachments	1 Year	Other Items Not Specified	3 Years
Accessories	6 Months		

RESIDENTIAL STRENGTH WARRANTY (NORTH AMERICA ONLY)

Frame (Not Coatings)**/ Cables & Pulleys / Weight Stacks	Lifetime	Attachments / Upholstery / Paint	2 Years
--	----------	----------------------------------	---------

** Frame is defined as the welded-metal base of the unit and does not include removable parts

Note: all specifications are subject to change without notice. Actual products may differ from those pictured in this catalog

Elite Series

CODE	PRODUCT NAME	Dimensions (IN)			Dimensions (CM)			Weight (lbs)	Weight (kg)
		L	W	H	L	W	H		
CF2152	Olympic Incline Press	51	54	62	129.5	137.2	157.5	220	99.8
CF2153	Olympic Decline Press	62	51	52	157.5	129.5	132.1	201	91.2
CF2157	Seated Preacher Curl	50	33	39	127	83.8	99.1	121	54.9
CF2159	Lunge Rack	68	67	77	172.7	170.2	195.6	247	112
CF2160	Standing Biceps	47	33	41	119.4	83.8	104.1	176	79.8
CF2171	Smith Machine	96	62	90	243.8	157.5	228.6	529	240
CF2172	Calf Raise	51	33	36	129.5	83.8	91.4	112	50.8
CF2173	Standing T-Bar Row	37	70	48	94	177.8	121.9	112	50.8
CF2175	Hack Squat	64	80	55	162.6	203.2	139.7	470	213.2
CF8131	Glute Press	46	80	44	116.8	203.2	111.8	355	161
CF8133	Glute Rocker	54	54	24	137.2	137.2	61	330	149.7
CF8137	Pendulum Squat	83	43	67	210.8	109.2	170.2	420	190.5

COMMERCIAL STRENGTH WARRANTY (NORTH AMERICA ONLY)

Frame (Not Coatings)**/ Weight Stacks / Pulleys / Pivot Bearings	10 Years	Cables / Pulleys / Parts / Hardware	5 Years
Upholstery / Springs / Grips / Paint / Attachments	1 Year	Other Items Not Specified	3 Years
Accessories	6 Months		

RESIDENTIAL STRENGTH WARRANTY (NORTH AMERICA ONLY)

Frame (Not Coatings)**/ Cables & Pulleys / Weight Stacks	Lifetime	Attachments / Upholstery / Paint	2 Years
--	----------	----------------------------------	---------

** Frame is defined as the welded-metal base of the unit and does not include removable parts

Note: all specifications are subject to change without notice. Actual products may differ from those pictured in this catalog

Foundation Series

CODE	PRODUCT NAME	Dimensions (IN)			Dimensions (CM)			Weight (lbs)	Weight (kg)
		L	W	H	L	W	H		
G701	Military Half Rack	64	51	94	162.6	129.5	238.8	440	199.6
G703	Military Full Rack	57	57	90	144.8	144.8	228.6	506	229.5
VFCR1702B	Full Lynx Rack System	254	63	94	645.2	160	238.8	2223	1008.3
VFCR1701A	Single Bay	50	36	94	127	91.4	238.8	505	229.1
VFCR1701B	Smith Machine	82	63	94	208.3	160	238.8	569	258.1
VFCR1701C	Cable Crossover	36	102	94	91.4	259.1	238.8	1047	474.9
VFCR1701D	Display Storage	102	36	94	259.1	91.4	238.8	1047	474.9

COMMERCIAL STRENGTH WARRANTY (NORTH AMERICA ONLY)

Frame (Not Coatings)**/ Weight Stacks / Pulleys / Pivot Bearings	10 Years	Cables / Pulleys / Parts / Hardware	5 Years
Upholstery / Springs / Grips / Paint / Attachments	1 Year	Other Items Not Specified	3 Years
Accessories	6 Months		

RESIDENTIAL STRENGTH WARRANTY (NORTH AMERICA ONLY)

Frame (Not Coatings)**/ Cables & Pulleys / Weight Stacks	Lifetime	Attachments / Upholstery / Paint	2 Years
--	----------	----------------------------------	---------

** Frame is defined as the welded-metal base of the unit and does not include removable parts

Note: all specifications are subject to change without notice. Actual products may differ from those pictured in this catalog

Alliance Series

CODE	PRODUCT NAME	Dimensions (IN)			Dimensions (CM)			Weight (lbs)	Weight (kg)	Weight Stack (lbs)	Weight Stack (kg)
		L	W	H	L	W	H				
GM5001	Cable Crossover	151	28	91	383.5	71.1	231.1	969	439.5	220*2; Upgradeable to 340*2	99.8*2; Upgradeable to 154.2*2
GM5003	Four Station/Position	144	80	87	365.8	203.2	221	687	311.6	220; Upgradeable to 340	99.8; Upgradeable to 154.2
GM5013	Four Station/Position w/ Chin Dip	144	95	90	365.6	241.7	228.9	1563	709		
GM5005	Five Station/Position	203	144	92	515.6	365.8	233.7	1463	663.6	220*5; Upgradeable to 340*2	99.8*5; Upgradeable to 154.2*5
GM5015	Five Station/Position w/ Chin Dip	264	180	92	670.4	457	233.7	2976	1350		
GM5004	Eight Station/Position	240	180	92	609.6	457.2	233.7	1957	887.7	220*2; Upgradeable to 340*2	99.8*2; Upgradeable to 154.2*2
GM5014	Eight Station/Position w/ Chin Dip	227	144	92	577.8	365.6	233.7	2001	907.7		
PC1801	Dual Cable Cross	97	141	98	246.4	358.1	248.9	968	439.1	200*2	90.7*2
MX1162-MF	Smith/Dual Adjustable Pulley	91	622	89	231.1	1579.9	226.1	1496	678.6	220*2; Upgradeable to 340	99.8*5; Upgradeable to 154.2
MTI4201	Multi-Gym Chest Press/Lat Pull Down	58	49	86	147.3	124.5	218.4	738	334.8	220*2; Upgradeable to 340	99.8*2; Upgradeable to 154.2
MTI4001	2 Station Multi-Gym - Chest/Back, Leg Extension/Curl	86	77	86	218.4	195.6	218.4	870	394.6	220*2; Upgradeable to 340	99.8*2; Upgradeable to 154.2
MTI4002	2 Station Multi-Gym - Chest/Back, Leg Press	94	69	86	237.8	176	218.4	886	402		
MTI4003	2 Station Multi-Gym - Chest/Back, Pec/Fly	94	77	77	239.6	195.4	195.4	710	322		
MTI4005	3 Station Multi-Gym - Chest/Back, Leg Extension, Leg Press	105	84	86	266.7	213.4	218.4	2108	956.2	220*5; Upgradeable to 340	99.8*5; Upgradeable to 154.2
MTI4007	3 Station Multi-Gym - Chest/Back, Leg Extension, Pec/Fly	119	87	86	301.3	220	218.4	1127	511		
MTI4009	4 Station Multi-Gym - Chest, Leg Ext, Leg Press, Column Pulley	105	93	88	266.9	237.1	224	1723	781.6		
MTI4010	4 Station Multi-Gym - Chest, Leg Ext, Leg Press, Pec/Fly	117	105	86	297.8	266.9	218.4	1866	846.3		
MTI4016	5 Station Multi-Gym - Chest, Leg Ext, Leg Press, Cable Cross	220	105	90	559.9	266.9	228.2	1550	703		

COMMERCIAL STRENGTH WARRANTY (NORTH AMERICA ONLY)

Frame (Not Coatings)**/ Weight Stacks / Pulleys / Pivot Bearings	10 Years	Cables / Pulleys / Parts / Hardware	5 Years
Upholstery / Springs / Grips / Paint / Attachments	1 Year	Other Items Not Specified	3 Years
Accessories	6 Months		

RESIDENTIAL STRENGTH WARRANTY (NORTH AMERICA ONLY)

Frame (Not Coatings)**/ Cables & Pulleys / Weight Stacks	Lifetime	Attachments / Upholstery / Paint	2 Years
--	----------	----------------------------------	---------

** Frame is defined as the welded-metal base of the unit and does not include removable parts

Note: all specifications are subject to change without notice. Actual products may differ from those pictured in this catalog

Universal Series

CODE	PRODUCT NAME	Dimensions (IN)			Dimensions (CM)			Weight (lbs)	Weight (kg)	Weight Stack (lbs)	Weight Stack (kg)
		L	W	H	L	W	H				
MX1162	Universal Trainer	91	62	90	231.1	157.5	228.6	1470	666.8	220*2; Upgradeable to 340	99.8*2; Upgradeable to 154.2
MX1162-MF	MF Smith/Daps	91	622	89	231.1	1579.9	226.1	1496	678.6	220*2; Upgradeable to 340	99.8*5; Upgradeable to 154.2
MX1161FX	Dynamic Trainer	60	48	89	152.4	121.9	226.1	1035	469.5	220*2; Upgradeable to 340	99.8*2; Upgradeable to 154.2
MX1174	Universal 1 - Single Station Adjustable Pulley System	50	48	85	127	121.9	215.9	670	303.9	220; Upgradeable to 340	99.8; Upgradeable to 154.2
MX1179	Universal FID Bench V2	27	67	19	68.6	170.2	48.3	80	36.3		
MX1167	Leg Extension/Leg Curl Attachment										
MX1168	Preacher Curl Attachment										
MX1151	Multi Flexion Bench	48	34	30	121.9	86.4	76.2	98	44.5		

COMMERCIAL STRENGTH WARRANTY (NORTH AMERICA ONLY)

Frame (Not Coatings)**/ Weight Stacks / Pulleys / Pivot Bearings	10 Years	Cables / Pulleys / Parts / Hardware	5 Years
Upholstery / Springs / Grips / Paint / Attachments	1 Year	Other Items Not Specified	3 Years
Accessories	6 Months		

RESIDENTIAL STRENGTH WARRANTY (NORTH AMERICA ONLY)

Frame (Not Coatings)**/ Cables & Pulleys / Weight Stacks)	Lifetime	Attachments / Upholstery / Paint	2 Years
---	----------	----------------------------------	---------

** Frame is defined as the welded-metal base of the unit and does not include removable parts

Note: all specifications are subject to change without notice. Actual products may differ from those pictured in this catalog

Attachments

CODE	PRODUCT NAME	Dimensions (IN)			Dimensions (CM)			Weight (lbs)	Weight (kg)
		L	W	H	L	W	H		
340-U	340lb Weight Stack Upgrade (Per Stack)								
MX1161-PS	High/Low Pulley System For Dynamic Trainer	9	40	90.4	22.86	101.6	229.6	45	20.4
MX1155	Dip Bar/ Knee Raise								
MX1164	Inverted Leg Press Attachment	24	16	4	61	40.6	10.2	15	6.8
MX1165	Lat Seat	26	21	21	66.4	54	54	32	14.5
MX1166	Dip Bar	33	28	11	84.1	71.5	27	18	8
MX1171	Universal Trainer Jammer Arms	41	27	8	104.1	68.6	20.3	80	36.3
MX1175	Leg Extension/Curl Seat Attachment	23	33	22.5	58.4	83.8	57.2		0
MX1178	Universal Trainer Side Mount Attachment Rack	13	5	46	32	12.2	117.8	20*2	8.9*2
MX1183	Isolateral Leg Press Attachment	24	50	51	61	127	129.5	60	27.2
MX1185	Attachment Diagram	22	14	1	55.9	35.6	2.5	10	4.5
MX1186	Back Mounted Accessory Rack	40	25	13	101.6	63.5	33	180	81.6
MX1188	Lat Seat with Leg Extension/Curl								
MX1189	Multi-Flight Attachment	40	25	13	101.6	63.5	33	25	11.3
MX1191	Universal Storage Rack	43.5	27.5	79	110.5	69.9	200.7	80	36.3
MX1192	Universal Trainer Low Row Footplate	22.5	13	8	57.2	33	20.3	18	8.2
MX1162-JH	J Hooks/Spotter Arms	6	4	9	15.6	9	22	5	2.4

COMMERCIAL STRENGTH WARRANTY (NORTH AMERICA ONLY)

Frame (Not Coatings)**/ Weight Stacks / Pulleys / Pivot Bearings	10 Years	Cables / Pulleys / Parts / Hardware	5 Years
Upholstery / Springs / Grips / Paint / Attachments	1 Year	Other Items Not Specified	3 Years
Accessories	6 Months		

RESIDENTIAL STRENGTH WARRANTY (NORTH AMERICA ONLY)

Frame (Not Coatings)**/ Cables & Pulleys / Weight Stacks)	Lifetime	Attachments / Upholstery / Paint	2 Years
---	----------	----------------------------------	---------

** Frame is defined as the welded-metal base of the unit and does not include removable parts

Note: all specifications are subject to change without notice. Actual products may differ from those pictured in this catalog

Attachments

CODE	PRODUCT NAME	Dimensions (IN)			Dimensions (CM)			Weight (lbs)	Weight (kg)
		L	W	H	L	W	H		
MX1162-LM	Landmine	19	3	4	48.5	7	10.5	7	3
MX1169-P	Preacher Curl Attachment For MX1169	21	18	29	54.6	46.5	74	26	12
MX1169-L	Leg Ex/Curl Attachment For MX1169	19	19	22	47.7	47	56	17	7.7

COMMERCIAL STRENGTH WARRANTY (NORTH AMERICA ONLY)

Frame (Not Coatings)**/ Weight Stacks / Pulleys / Pivot Bearings	10 Years	Cables / Pulleys / Parts / Hardware	5 Years
Upholstery / Springs / Grips / Paint / Attachments	1 Year	Other Items Not Specified	3 Years
Accessories	6 Months		

RESIDENTIAL STRENGTH WARRANTY (NORTH AMERICA ONLY)

Frame (Not Coatings)**/ Cables & Pulleys / Weight Stacks	Lifetime	Attachments / Upholstery / Paint	2 Years
--	----------	----------------------------------	---------

** Frame is defined as the welded-metal base of the unit and does not include removable parts
 Note: all specifications are subject to change without notice. Actual products may differ from those pictured in this catalog

Stacked Series

CODE	PRODUCT NAME	Dimensions (IN)			Dimensions (CM)			Weight (lbs)	Weight (kg)
		L	W	H	L	W	H		
GR801	Plate Loaded Chest Press	51	65	67	129.5	165.1	170.2	364	165.1
GR802	Plate Loaded Row	54	53	50	137.2	134.6	127	342	155.1
GR803	Plate Loaded Shoulder Press	55	59	58	139.7	149.9	147.3	331	150.1
GR804	Plate Loaded Incline Chest Press	44	74	66	111.8	188	167.6	342	155.1
GR805	Wide Chest Press	65	54	70	165.1	137.2	177.8	375	170.1
GR806	Plate Loaded Pull Down	72	49	77	182.9	124.5	195.6	375	170.1
GR807	Stacked Low Row	51	51	64	129.5	129.5	162.6	364	165.1
GR808	Squat Press	69	88	59	175.3	223.5	149.9	441	200
GR809	Standing Calf Raise	44	66	46	111.8	167.6	116.8	287	130.2
GR810	Rear Kick	49	52	64	124.5	132.1	162.6	331	150.1
FL1801	Isolateral Leg Press	87	63	72	221	160	182.9	783	355.2
FL1802	Lat Pulldown	71	53	83	180.3	134.6	210.8	293	132.9
FL1803	Seated Row	59	46	51	149.9	116.8	129.5	295	133.8
FL1804	Chest Press	40	63	71	101.6	160	180.3	320	145.1
FL1805	Seated Dip	71	45	37	180.3	114.3	94	363	164.7
FL1806	Super Squat	80	53	49	203.2	134.6	124.5	358	162.4
FL1808	Prone Leg Curl	75	62	30	190.5	157.5	76.2	227	103
FL1809	Isolateral Horizontal Swing Leg Press	51	75	70	129.5	190.5	177.8	810	367.4
FL1810	Leg Extension	75	57	49	190.5	144.8	124.5	500	226.8
FL1811	Adjustable Hack Squat	92	67	49	233.7	170.2	124.5	606	274.9
FL1814	Plate Loaded Chest Pullover	61	51	58	154.9	129.5	147.3	535	242.7
FL1816	Bench Press	607	689	413	1541	1749	1048	179	81
FL1817	Shoulder Press	61	75	73	154.9	190.5	185.4	293	132.9

COMMERCIAL STRENGTH WARRANTY (NORTH AMERICA ONLY)

Frame (Not Coatings)**/ Weight Stacks / Pulleys / Pivot Bearings	10 Years	Cables / Pulleys / Parts / Hardware	5 Years
Upholstery / Springs / Grips / Paint / Attachments	1 Year	Other Items Not Specified	3 Years
Accessories	6 Months		

RESIDENTIAL STRENGTH WARRANTY (NORTH AMERICA ONLY)

Frame (Not Coatings)**/ Cables & Pulleys / Weight Stacks	Lifetime	Attachments / Upholstery / Paint	2 Years
--	----------	----------------------------------	---------

** Frame is defined as the welded-metal base of the unit and does not include removable parts
 Note: all specifications are subject to change without notice. Actual products may differ from those pictured in this catalog

Stacked Series

CODE	PRODUCT NAME	Dimensions (IN)			Dimensions (CM)			Weight (lbs)	Weight (kg)
		L	W	H	L	W	H		
FL1823	Unilateral Bicep Curl	40	72	50	101.6	182.9	127	309	140.2
FL1825	Glute Ham Developer	35	58	49	88.5	146.8	125	149	67.7
FL1834	Belt Squat	66	68	87	167.6	172.7	221	288	130.6

COMMERCIAL STRENGTH WARRANTY (NORTH AMERICA ONLY)

Frame (Not Coatings)**/ Weight Stacks / Pulleys / Pivot Bearings	10 Years	Cables / Pulleys / Parts / Hardware	5 Years
Upholstery / Springs / Grips / Paint / Attachments	1 Year	Other Items Not Specified	3 Years
Accessories	6 Months		

RESIDENTIAL STRENGTH WARRANTY (NORTH AMERICA ONLY)

Frame (Not Coatings)**/ Cables & Pulleys / Weight Stacks	Lifetime	Attachments / Upholstery / Paint	2 Years
--	----------	----------------------------------	---------

** Frame is defined as the welded-metal base of the unit and does not include removable parts

Note: all specifications are subject to change without notice. Actual products may differ from those pictured in this catalog

Accessories

CODE	PRODUCT NAME	Dimensions (IN)			Dimensions (CM)			Weight (lbs)	Weight (kg)
		L	W	H	L	W	H		
MX1182	Squat Box - Belt Squat Platform	16.6	24.5	9.5	42.2	62.2	24.1		0
MX1182XL	Squat Box Pro - Portable Belt Squat Station (Without Handle Bar)	18	36	12	45.7	91.4	30.5		0
MX1182XL	Squat Box Pro - Portable Belt Squat Station (With Handle Bar)	25	53	48	63.5	134.6	121.9		0
MX1151	Multi-Flexion Bench	48	34	30	121.9	86.4	76.2	98	44.5
WT-EX	Weight Extender								
340-U	340lb Weight Stack Upgrade	15	4	8	37	10	20.3	120	54.4
ATT-AS	Ankle Strap	23	3	1.2	57.5	8	3	1.26	0.57
ATT-CH	Cable Handles (Single)	10	6	3	26	15	7.5	0.35	0.16
ATT-DPB	Double Pulley Bar								
ATT-LB	Aluminum Lat Bar	49	4	1.3	123.8	11.2	3.2	3	1.5
ATT-TB	Tricep Bar								
ATT-TR	Tricep Rope								
ATT-PA	Pull Up Assist Strap								
FL1834-BLT	Replacement Belt For FL1834	43	4	0.5	110	10	1.2	4	1.7
FL1844-BLT	Replacement Belt For FL1844	39	4	0.3	98	10	0.7	1.32	0.6
FL1844-BLT	Replacement Belt For FL1844	17	4	0.3	42	10	0.7	0.88	0.4
MX1182-BLT	Replacement Belt For MX1182								
MX1182-GYM	Gym Kit For MX1182								
MX1182-HOME	Home Kit For MX1182								

COMMERCIAL STRENGTH WARRANTY (NORTH AMERICA ONLY)

Frame (Not Coatings)**/ Weight Stacks / Pulleys / Pivot Bearings	10 Years	Cables / Pulleys / Parts / Hardware	5 Years
Upholstery / Springs / Grips / Paint / Attachments	1 Year	Other Items Not Specified	3 Years
Accessories	6 Months		

RESIDENTIAL STRENGTH WARRANTY (NORTH AMERICA ONLY)

Frame (Not Coatings)**/ Cables & Pulleys / Weight Stacks	Lifetime	Attachments / Upholstery / Paint	2 Years
--	----------	----------------------------------	---------

** Frame is defined as the welded-metal base of the unit and does not include removable parts

Note: all specifications are subject to change without notice. Actual products may differ from those pictured in this catalog

Smart Sled Pro

CODE	PRODUCT NAME	Dimensions (IN)			Dimensions (CM)			Weight (lbs)	Weight (kg)
		L	W	H	L	W	H		
BK-SS01	Smart Sled Pro	45	40	31	114.3	101.6	78.7	250	113.4
MFPS-01	Magforce Power Sled	45	40	31	114.3	101.6	78.7	250	113.4

COMMERCIAL STRENGTH WARRANTY (NORTH AMERICA ONLY)

Frame (Not Coatings)**/ Weight Stacks / Pulleys / Pivot Bearings	10 Years	Cables / Pulleys / Parts / Hardware	5 Years
Upholstery / Springs / Grips / Paint / Attachments	1 Year	Other Items Not Specified	3 Years
Accessories	6 Months		

RESIDENTIAL STRENGTH WARRANTY (NORTH AMERICA ONLY)

Frame (Not Coatings)**/ Cables & Pulleys / Weight Stacks	Lifetime	Attachments / Upholstery / Paint	2 Years
--	----------	----------------------------------	---------

** Frame is defined as the welded-metal base of the unit and does not include removable parts

Note: all specifications are subject to change without notice. Actual products may differ from those pictured in this catalog